

Model SP-11CDP
Remotely-Controlled
10-Disc CD Changer



OWNER'S
MANUAL

HINTS FOR CORRECT AND SAFE OPERATION

This CD Changer is designed to be operated only on 12 volt DC negative ground systems. The unit can not be used on 24 volt or positive ground systems.

TEMPERATURE

The unit may not operate correctly in extremely hot or cold temperatures. It is equipped with a built-in thermal protection circuit which will stop operation of the unit when the temperature reaches the pre-set level. If this should happen, the unit will resume operation when the vehicle returns to a normal temperature range.

Remove the magazine from the unit when it is not being used during hot weather. If the discs are left in an extremely hot car they may warp. If the CD changer is not used for long periods of time, remove the compact discs from the magazine, and store them in their cases.

CONDENSATION

Moisture can condense on the laser lens of the CD changer during rainy and humid days, or right after the heater is turned on in the car (if the changer is mounted in the passenger compartment). If this should happen the unit will not operate correctly. To remedy the situation, remove the discs from the unit and wait approximately one hour. During this time the moisture will evaporate and the unit will operate normally.

INTERRUPTIONS IN SOUND (Skipping)

The sound from the unit may "skip" and be interrupted if the anti-vibration springs are not set correctly, if the changer is mounted on-end or upside-down, or when travelling on very rough road surfaces. If this should occur, check for errors made during installation or wait for the road surface to improve.

3" (8cm) CD-SINGLES

This unit is not designed to play 3" (8cm) CD-Single discs. Inserting a 3" disc into the magazine, either with or without a 3" disc adaptor, can damage the changer and the disc. Such damage will not be covered by the Warranty on this product.

HANDLING THE DISCS

Dirt, dust, scratches and warpage cause sound skips during playback and a deterioration of sound quality. To take proper care of your discs:



1. Use compact discs that have the  logo.
2. Fingerprints and dust should be carefully wiped off the disc's signal surface (glossy side) with a soft cloth. Unlike conventional records, the compact disc has no grooves to collect dust and microscopic debris, so gently wiping with a soft cloth should remove most particles. Wipe in a straight motion from the inside to the outside of the disc. Small dust particles or light stains will have absolutely no effect on reproduction quality.
3. Never use such chemicals as record sprays, antistatic sprays or fluids, benzine or thinner to clean compact discs. Such chemicals could irreparably damage the disc's plastic surface.
4. Discs should be put back in their cases after use to avoid serious scratches that could cause the sound to skip.
5. Do not expose discs to direct sunlight, high humidity, or high temperatures for extended periods of time. Long exposure to high temperatures can warp the disc.
6. Do not stick paper, labels, or tape on the disc surface.
7. Do not write with any type of pen, pencil, or marker on the disc surface.
8. To minimize fingerprints and smudges on the signal surface, always try to hold the discs by their outer edge and center hole.

USE OF THE CD MAGAZINE

LOADING DISCS INTO THE MAGAZINE

This CD Changer uses a specially-designed magazine to hold up to 10 compact discs. To load discs into the magazine, grip the tab on the magazine tray into which you will be loading a disc and pull it out gently as shown in Figure 1. Pull out only one tray at a time. Insert a disc into the tray with the label side up (play surface facing down) as shown in Figure 2. Push the tray back into the magazine as shown in Figure 3. Load discs into the remaining 9 trays in a similar manner.

REMOVING DISCS FROM THE MAGAZINE

To remove a disc from the magazine, pull out the tray of the disc to be removed, lift out the disc, and push the tray back into the magazine.

NOTES:

- Avoid touching the playing side of the disc.
- Only one disc can be inserted into each tray of the magazine. Do not try to insert more than one disc into each tray as damage to the discs and magazine may occur.
- This changer is not designed to play 3" CD-Single discs (8cm). Inserting a 3" disc into the magazine, either with or without a 3" disc adaptor, can damage the changer and the disc. Such damage will not be covered by the Warranty on this product.
- Additional CD magazines are available as accessory item part number **SP11M** from your Audiovox dealer, or you may contact us directly at:

Attention: Parts Division
Audiovox Corporation
150 Marcus Blvd., Hauppauge, NY 11788
www.Audiovox.com and/or 1-800-645-4994

Fig. 1

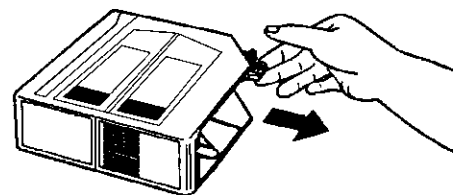

Fig. 2

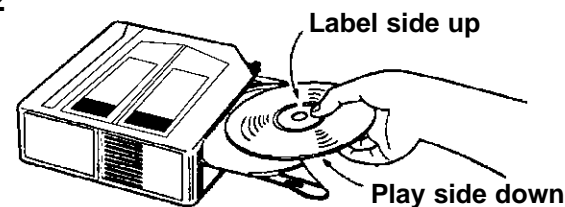
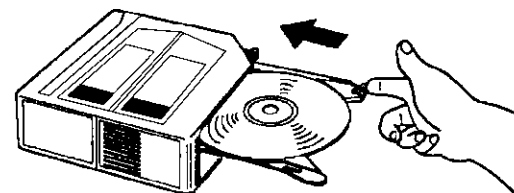

Fig. 3



LOADING THE MAGAZINE INTO THE CHANGER

Completely slide the door on the changer to the right as shown in Figure 4. Making sure the top of the magazine is facing upward, gently insert it into the unit until it clicks into place, as shown in Figure 5. Slide the door of the changer fully closed and the unit is ready for operation.

REMOVING THE MAGAZINE FROM THE CHANGER

The magazine can be removed from the changer using one of two methods as outlined below in steps a and b.

NOTE: Be sure to keep the door on the changer closed at all times when not loading or removing the magazine. Leaving the door open could allow dust, dirt and moisture to enter the changer which could cause the unit to malfunction.

- a. During normal operation with power applied, slide open the door on the changer and press the eject button as shown in Figure 6. The magazine will eject and can be removed.
- b. If the magazine will not eject in a normal manner, remove power by disconnecting the DIN cable from the changer.
 1. Slide open the magazine door. At the lower left rear of the changer, as shown in Figure 6, insert a thin-bladed screwdriver straight into the access hole about 1-1/2 inches until it contacts the release tab.
 2. Lightly leverage the blade to the right and the magazine will disengage and be ejected.

Fig. 4

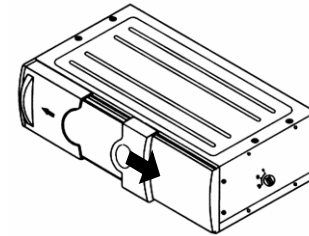

Fig. 5

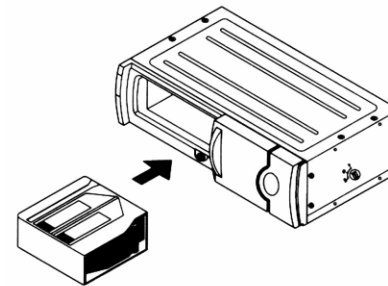
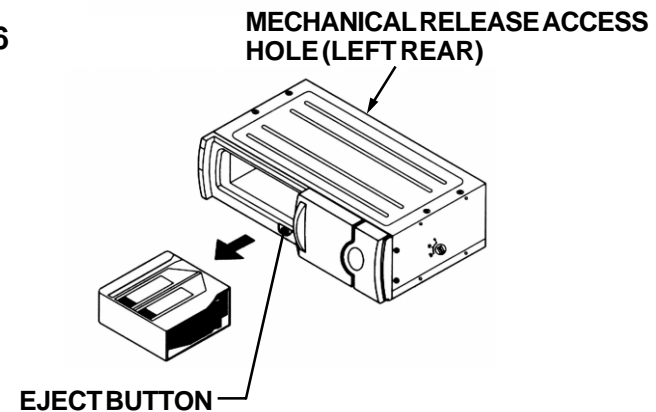

Fig. 6



CD CHANGER OPERATING INSTRUCTIONS

This CD Changer is designed to operate through a compatible Audiovox car stereo which incorporates the controls and display functions or through the FM section of any car stereo (requires accessory item CDC-MC1, CDC-MCR2, P-MC3 or P-MCR4 FM Modulator and Controller). Please check with your Audiovox stereo specialist for recommendations of the models that will work with this changer. The specific operating instructions for the changer will be contained within the Owner's Manual of the compatible unit.

SPECIFICATIONS:

Frequency Response:	5 - 20,000 Hz \pm 1dB
Distortion:	0.008% @ 1kHz
Dynamic Range:	95 dB
Signal-to-Noise Ratio:	85 dB
Channel Separation:	80 dB @ 1kHz
Wow & Flutter:	below measurable limits
Dimensions:	9-5/8" W x 3-3/8" H x 6-7/8" D 245 mm x 85 mm x 174 mm
Operating Voltage:	12 Volts DC, negative ground
Current Drain:	800mA (Playback/loading/ejecting)
Accessories Supplied:	10-disc magazine, P/N SP11M Mounting hardware (1set) Connecting cable (1ea.)

TROUBLESHOOTING

An error made in operation or during installation of this product may be mistaken for a system malfunction. Please perform the checks described below before contacting your dealer or service facility.

Symptom	Possible Cause	Remedy
No power	Blown fuse	Check fuses in vehicle fuse box and changer system. Replace as necessary with fuse of same type and rating as original. If fuse blows again, consult with service facility.
	Incorrect connection	Check all wiring and correct as necessary.
Magazine cannot be installed	Magazine is inserted in wrong direction.	Insert magazine in proper direction.
CD is not played	Disc is loaded incorrectly in magazine.	Load disc correctly in the magazine.
Noise, skipping, or intermittent sound during playback.	Scratches on disc or warped disc	Check sound on another disc. If sound from second disc is OK, first disc is defective.
	Extremely dirty disc	Clean disc
	Transit screws still in place	Remove the transit screws from sides of the unit.
	Mounting angle adjustment is not correct.	Set the mounting angle adjustment to the correct position as per the installation instructions.



AUDIOVOX

36 MONTH LIMITED WARRANTY

Applies to automotive CD changers

AUDIOVOX CORPORATION (the Company) warrants to the original retail purchaser of this product that should this product or any part thereof, under normal use and conditions, be proven defective in material or workmanship within 36 months from the date of original purchase, such defect(s) will be repaired or replaced with new or reconditioned product (at the Company's option) without charge for parts and repair labor.

To obtain repair or replacement within the terms of this Warranty, the product is to be delivered with proof of warranty coverage (e.g. dated bill of sale), specification of defect(s), transportation prepaid, to an approved warranty station or the Company at the address shown below.

This Warranty does not extend to the elimination of externally generated static or noise, to correction of antenna problems, to costs incurred for installation, removal or reinstallation of the product, or to damage to tapes, compact discs, speakers, accessories, or vehicle electrical systems.

This Warranty does not apply to any product or part thereof which, in the opinion of the Company, has suffered or been damaged through alteration, improper installation, mishandling, misuse, neglect, accident, or by removal or defacement of the factory serial number/bar code label(s). THE EXTENT OF THE COMPANY'S LIABILITY UNDER THIS WARRANTY IS LIMITED TO THE REPAIR OR REPLACEMENT PROVIDED ABOVE AND, IN NO EVENT, SHALL THE COMPANY'S LIABILITY EXCEED THE PURCHASE PRICE PAID BY PURCHASER FOR THE PRODUCT.

This Warranty is in lieu of all other express warranties or liabilities. ANY IMPLIED WARRANTIES, INCLUDING ANY IMPLIED WARRANTY OF MERCHANTABILITY, SHALL BE LIMITED TO THE DURATION OF THIS WRITTEN WARRANTY. ANY ACTION FOR BREACH OF ANY WARRANTY HEREUNDER INCLUDING ANY IMPLIED WARRANTY OF MERCHANTABILITY MUST BE BROUGHT WITHIN A PERIOD OF 48 MONTHS FROM DATE OF ORIGINAL PURCHASE. IN NO CASE SHALL THE COMPANY BE LIABLE FOR ANY CONSEQUENTIAL OR INCIDENTAL DAMAGES FOR BREACH OF THIS OR ANY OTHER WARRANTY, EXPRESS OR IMPLIED, WHATSOEVER. No person or representative is authorized to assume for the Company any liability other than expressed herein in connection with the sale of this product.

Some states do not allow limitations on how long an implied warranty lasts or the exclusion or limitation of incidental or consequential damage so the above limitations or exclusions may not apply to you. This Warranty gives you specific legal rights and you may also have other rights which vary from state to state.

U.S.A. : AUDIOVOX CORPORATION, 150 MARCUS BLVD., HAUPPAUGE, NEW YORK 11788 • 1-800-645-4994

CANADA : CALL 1-800-645-4994 FOR LOCATION OF WARRANTY STATION SERVING YOUR AREA

128-5538